



**WHAT IS CONTOURING FOR RAIN? WHAT IS A SWALE?**

Your garden features a 'dry creek' style swale. This is an area that is lightly graded to infiltrate water and eliminate runoff from the landscape surface to the street.

Over time, the plants may grow over the side of the swale, but it will still function.

The purpose of a swale is to allow soil to cleanse water as it passes through as groundwater. Water allowed to run off our landscapes and down our streets to the ocean creates dirty outflows and polluted beaches. Healthy garden soil has the ability to filter, cleanse and purify land based pollution before it gets to

**A: Rain Garden (planted)**

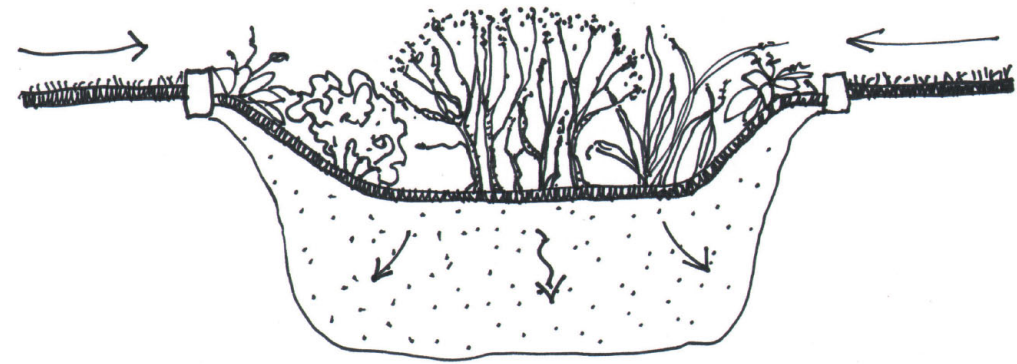

**B: 'Dry Creekbed' (rocks and pebbles)**

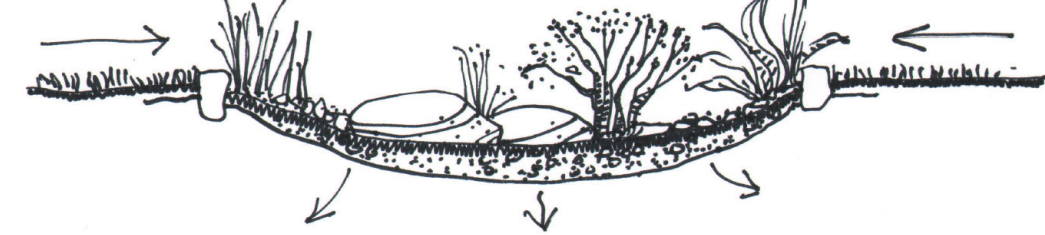

**C: Rain Garden on Slope**

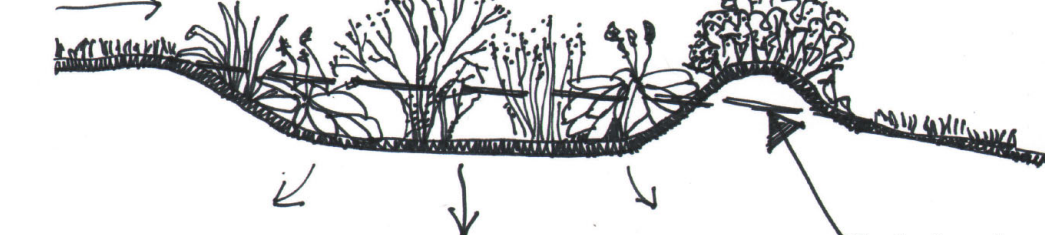

Swales and Rain Gardens are designed to infiltrate water within 48 hours or less. As these plants grow into their mature form the swale may not be as visible but will still function to infiltrate rain and eliminate runoff.

Swales are always designed to direct high stormwater flows toward existing drains.

**Selected Plant Photos:**

\*Please note: If plants pictured are not available, a plant with similar size, growth habit and aesthetic character will be substituted.

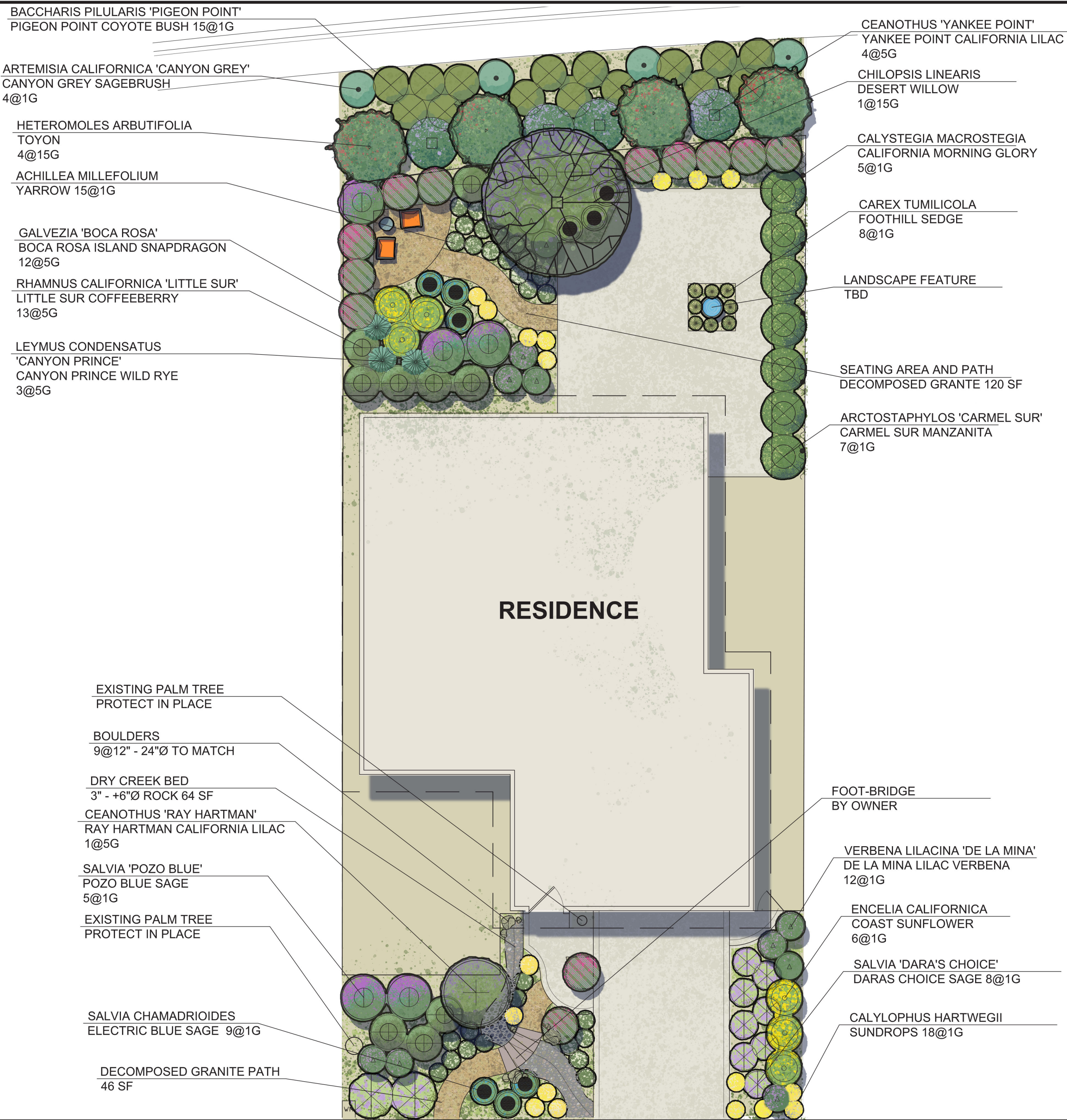
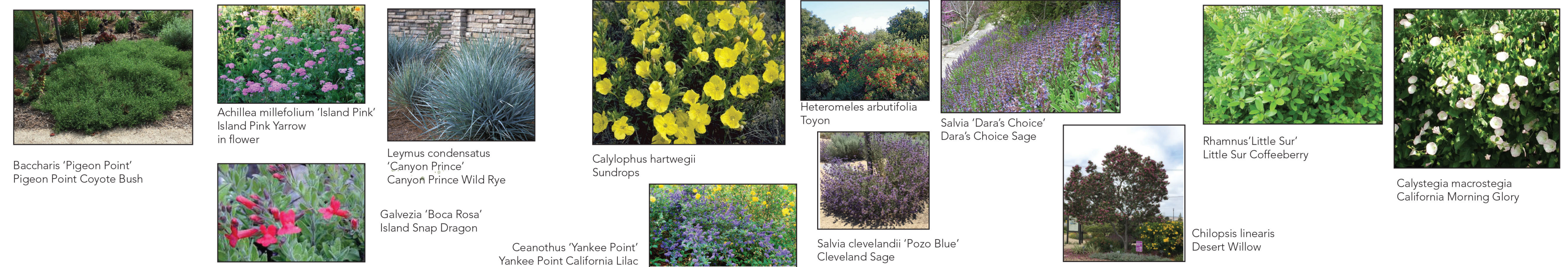

**California Native Garden** Congratulations! You are about to embark upon a fun, rewarding and ultimately important journey. The conversion of your lawn to a sustainable native garden. You are now part of a growing community of homeowners and garden-lovers returning a sense of place to the front and backyards of urban and suburban Southern California. Welcome home.

**ADDING PERSONALITY TO YOUR GARDEN:**

As Your Garden Grows...you will want to add personality and your own creative touch to your garden. Don't be afraid to experiment with containers, birdbaths, sculpture and other features to add your own unique touch to your garden. While the elements below are not included in your kit, they are all readily available throughout Southern California and beyond.



CONTAINERS OUTDOOR ART

**Partner With Nature!** Installing rain barrels or creating a swale in your garden stores rainwater for your native plants to use. Consider incorporating these elements of sustainability into your new garden.

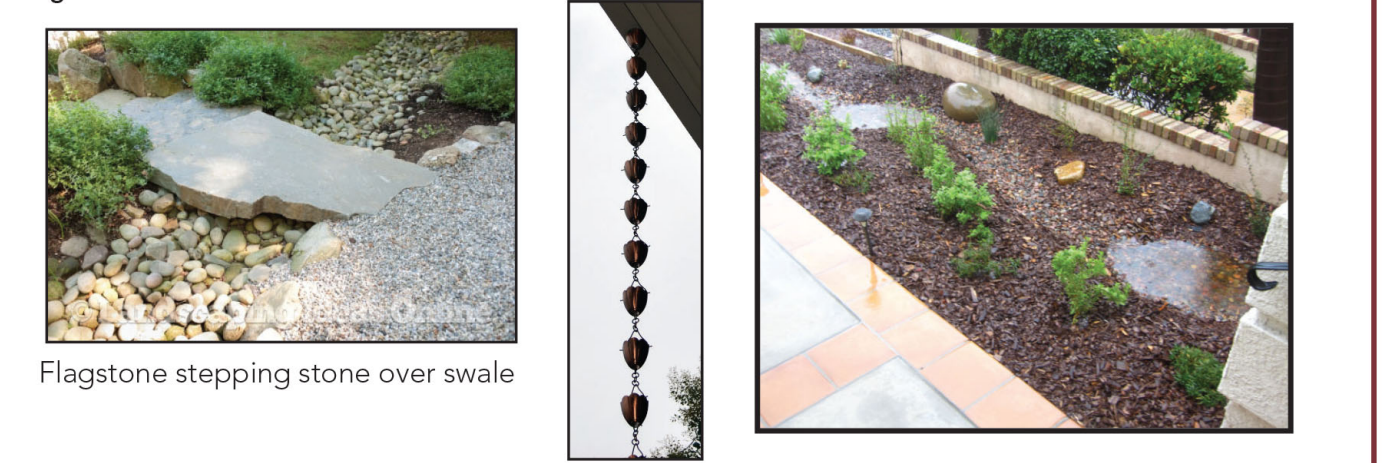

Flagstone stepping stone over swale RAINWATER CAPTURE, RAIN CHAINS and SWALES



**Coastal Garden - Full Sun/Part Shade in Sunset Zones 22, 24**

This garden is designed to compliment the natural features of coastal Southern California. It will be completely drought tolerant and self-sustaining once established. Local species as well as native plant varieties from coastal environments have been selected. Permeable hardscape surfaces and contouring the land allows rainwater to replenish the soil.

This garden is diverse! It will come to life with different plant species and seasonal flowers, all of which will attract birds, butterflies, hummingbirds and beneficial pollinators. Your new Coastal Garden will offer many possibilities for future fine tuning as you add more details and personality into the design. There are dozens of wonderful plants that can be used in this basic coastal design and we encourage you to include more variety as your garden matures.

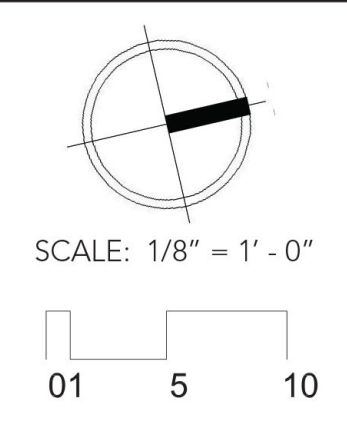

**Planting Concept**

